

# CVO Inspection Facilities Interconnect Diagram

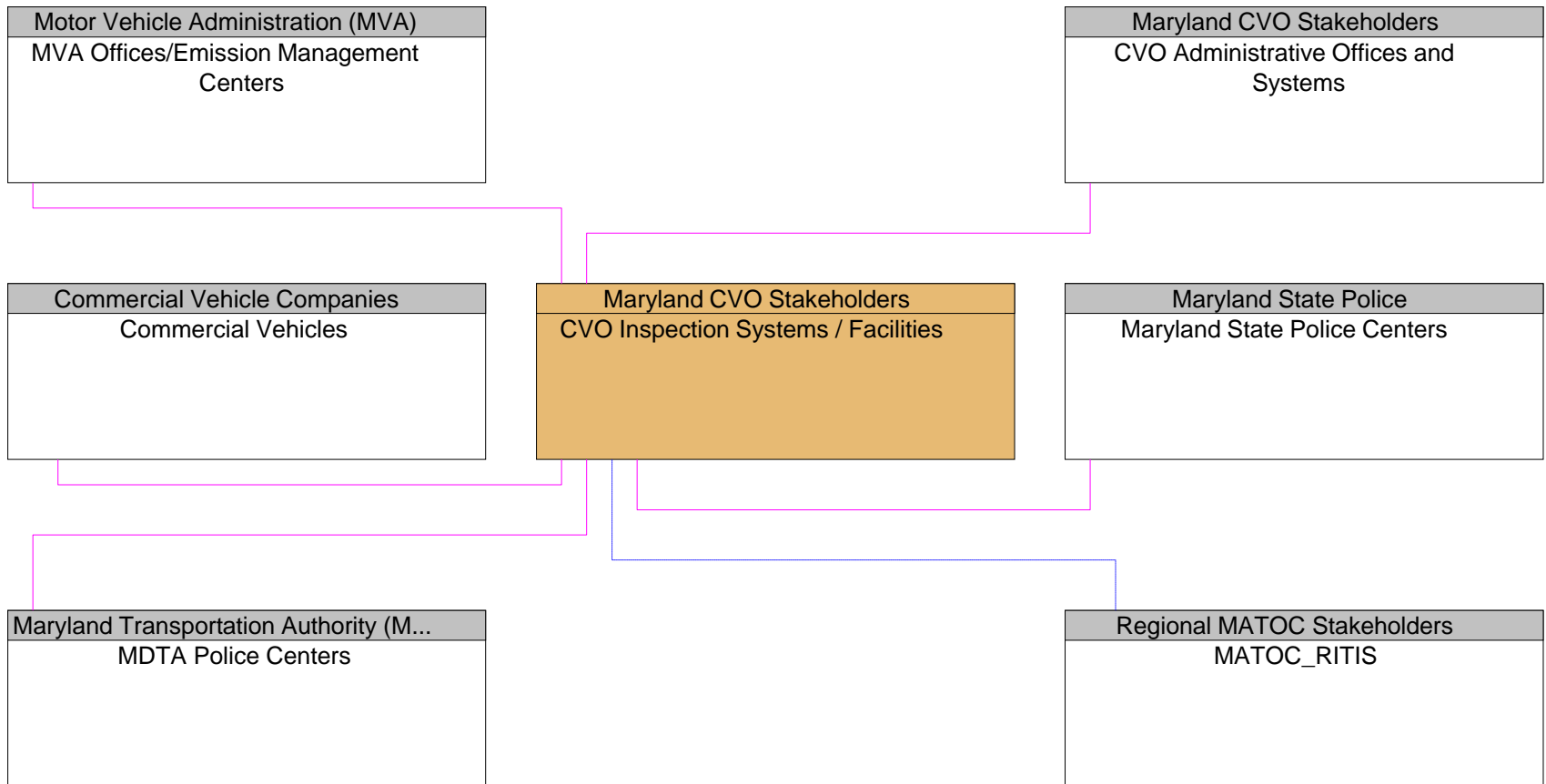

Existing  
Planned

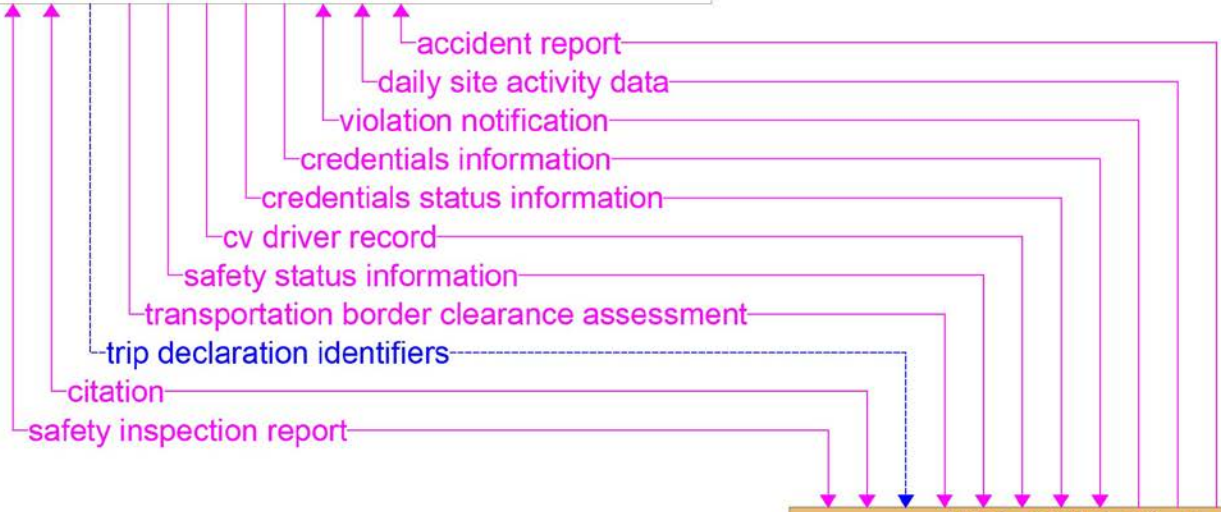
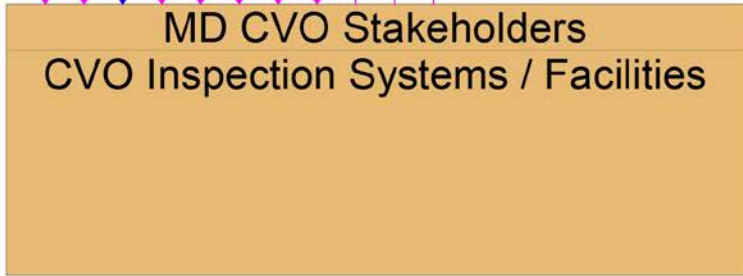
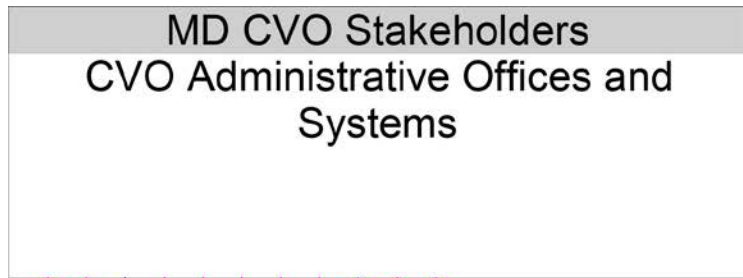

———— Existing  
 - - - - - Planned

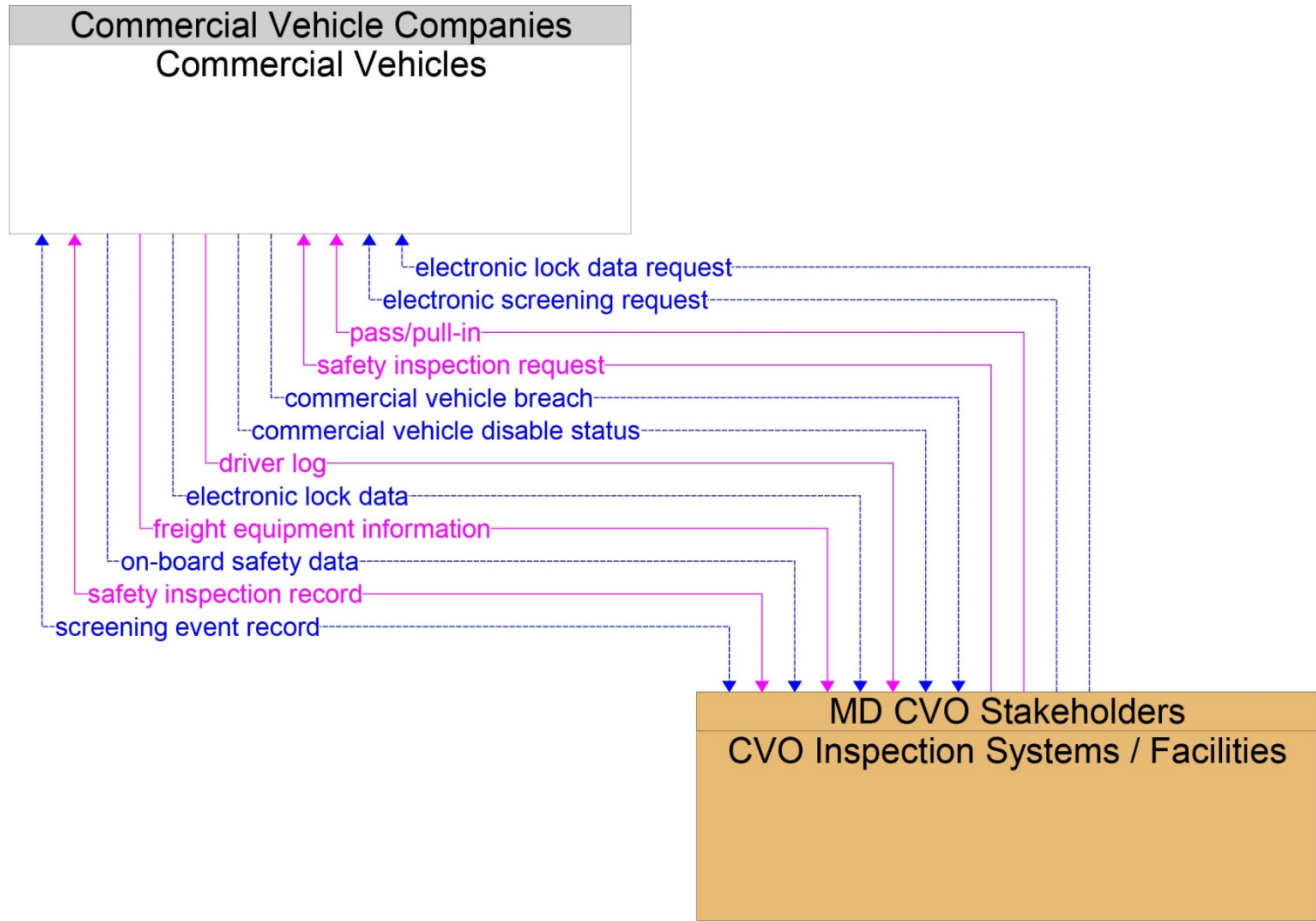

MD CVO Stakeholders  
CVO Inspection Systems / Facilities

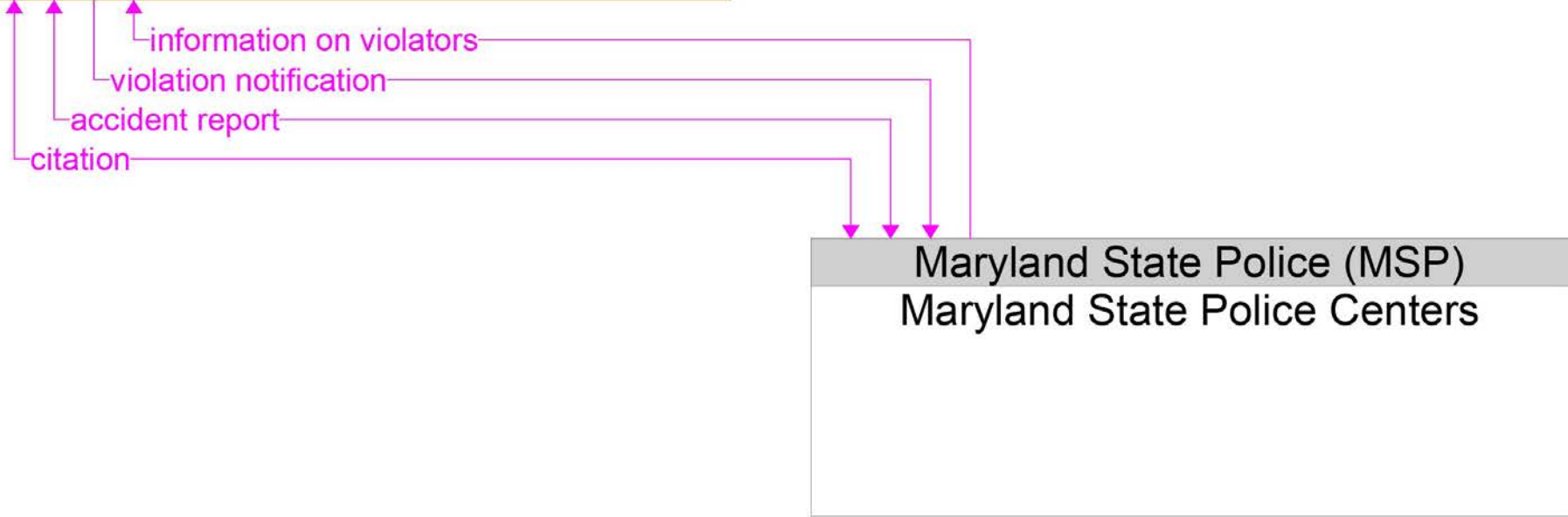

MD CVO Stakeholders  
CVO Inspection Systems / Facilities

alarm

Regional MATOC Stakeholders  
MATOC\_RITIS

Planned

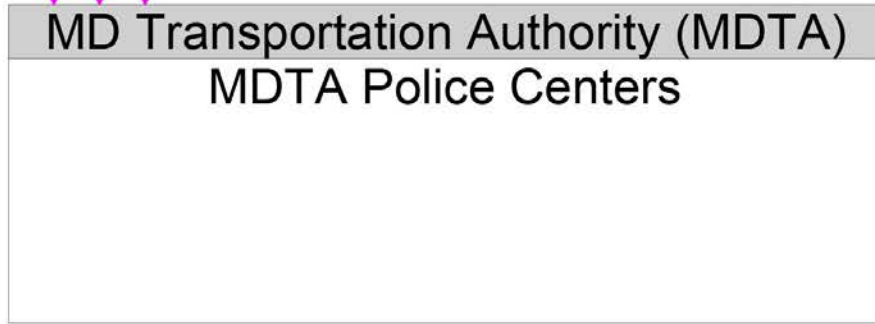
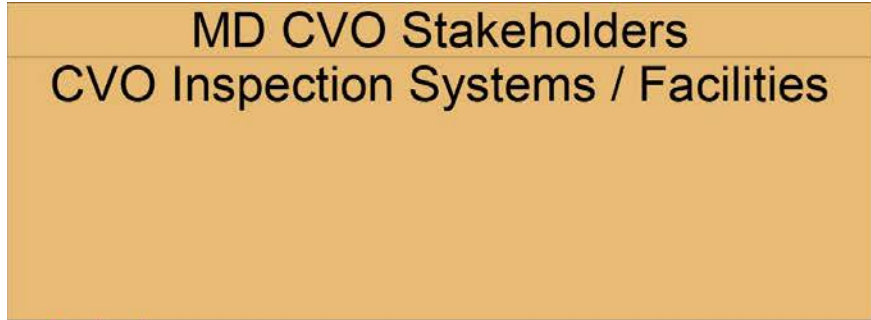

Existing

Motor Vehicle Administration (MVA)  
MVA Offices/Emission Management  
Centers



MD CVO Stakeholders  
CVO Inspection Systems / Facilities

Existing